

POOLSPA

PRICE LIST 2024
PREPLUMBED SPA BATHTUBS



SPA MILA

spa shell
POOLSPA

PL
**POLISH
PRODUCER**

**HIGH QUALITY
COMPONENTS**

25
YEAR EXPERIENCE
IN BATHTUB
MANUFACTURE

www.poolspa.pl



SPA VICTORIA

POOLSPA

PRICE LIST 2024

STATIONARY SPA BATHTUBS

MILA 250 x 250 with gutter.....	4
MILA 250 x 250 with gutter, 32 jets	5
OLIMPIA 250 x 250 with gutter	6
OLIMPIA 250 x 250 with gutter, 32 jets.....	7
JANETTE 175 x 193 with skimmer	8
JANETTE 197 x 215 with gutter	8
JANETTE 197 x 215 with gutter, 32 jets	9
OCTAVIA 179 x 179 with skimmer	10
OCTAVIA 226 x 226 with gutter	10
OCTAVIA 226 x 226 with gutter, 32 jets	11
VICTORIA Ø 177 with skimmer	12
VICTORIA Ø 249 with gutter	12
VICTORIA Ø 249 with gutter, 32 jets	13
CLASSIC 186 x 213 with skimmer	14
CLASSIC 260 x 234 with gutter	14
CLASSIC 260 x 234 with gutter, 32 jets.....	15
NATALIE 253 x 253 with gutter.....	16
NATALIE 253 x 253 with gutter, 32 jets	17
SUNFLOWER Ø 283 with gutter.....	18
SUNFLOWER Ø 283 with gutter, 32 jets.....	19
VESTA 230 x 230 with skimmer.....	20
VESTA 290 x 290 with gutter.....	20
VESTA 290 x 290 with gutter, 32 jets	21
OLIVIA 248 x 299 with gutter	22
OLIVIA 248 x 299 with gutter, 32 jets	23
Plumbing schemes	24
Jet layouts.....	26
Warranty.....	27

PRODUCT / EQUIPMENT	CATALOGUE NO.	NET PRICE EUR
32 jets SPA preplumbed with air channels + white LED light	PWW7A10U32B0209	14 000
SPA preplumbed with air channels + 24 multicolor LED lights	PWW7A10U32B1885	15 100
Full foaming		570
Brown thermal cover	PI9000308	2 500

MILA 250 × 250

with gutter, 32 jets

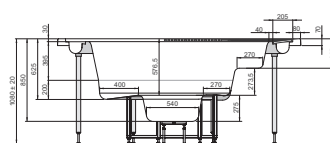
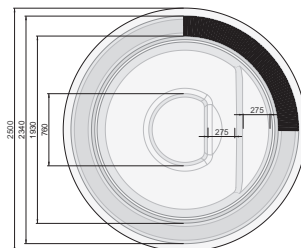

GENERAL INFORMATION

length:	250 cm	number of jets:	32
width:	250 cm	number of air holes:	89
height:	108 ±2 cm	number of suctions:	4
number of seats:	5	number of hidden air inlets:	4
capacity:	1380 l	number of massage points:	121

Jets layout A

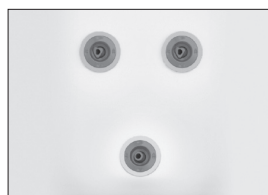

Jets layout B

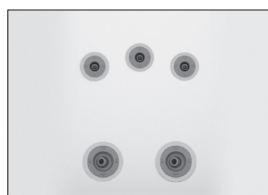

Jets layout F



Jets layout D

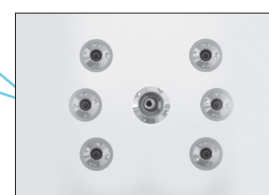

STATIONARY SPA BATHTUBS

MULTI-USER, PREPLUMBED VERSIONS

POOLSPA

OLIMPIA 250 × 250

with gutter

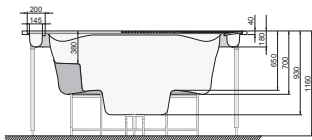
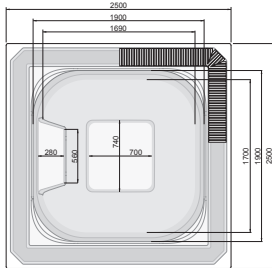

	PRODUCT / EQUIPMENT	CATALOGUE NO.	NET PRICE EUR
7 jets	SPA preplumbed with air channels	PWW7110U00B0000	11 400
	SPA preplumbed with air channels + white LED light	PWW7110U00B0209	11 800
	SPA preplumbed with air channels + 24 multicolor LED lights	PWW7110U00B1885	12 900
14 jets	SPA preplumbed with air channels	PWW7110U02B0000	12 800
	SPA preplumbed with air channels + white LED light	PWW7110U02B0209	13 200
	SPA preplumbed with air channels + 24 multicolor LED lights	PWW7110U02B1885	14 300
	Full foaming		570
	Brown thermal cover	PI9000580	2 600

GENERAL INFORMATION

length:	250 cm	number of jets:	7-14
width:	250 cm	number of air holes:	106
height:	116 ± 2 cm	number of suction:	3-4
number of seats:	7	number of hidden air inlets:	2-4
capacity:	2000 l	number of massage points:	113-120

	PRODUCT / EQUIPMENT	CATALOGUE NO.	NET PRICE EUR
32 jets	SPA preplumbed with air channels + white LED light	PWW7110U32B0209	14 800
	SPA preplumbed with air channels + 24 multicolor LED lights	PWW7110U32B1885	15 900
	Full foaming		570
	Brown thermal cover	PI9000580	2 600

OLIMPIA 250 × 250

with gutter, 32 jets

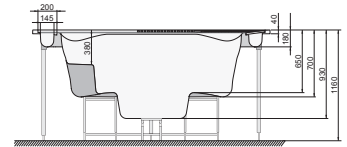
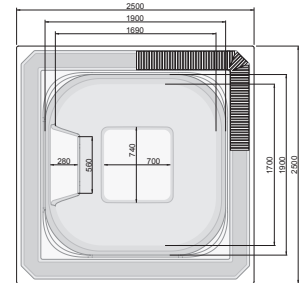

GENERAL INFORMATION

length:	250 cm	number of jets:	32
width:	250 cm	number of air holes:	106
height:	116 ± 2 cm	number of suctions:	4
number of seats:	7	number of hidden air inlets:	4
capacity:	2000 l	number of massage points:	138

Jets layout C



Jets layout E

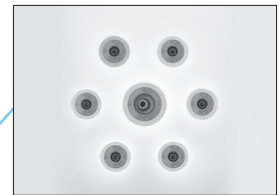

Jets layout B

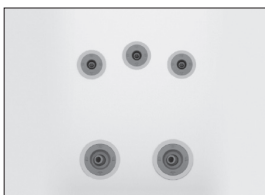

Jets layout F

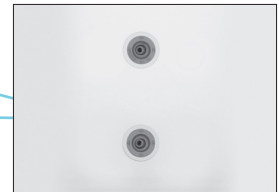

Jets layout A

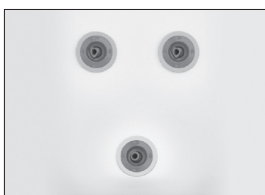

Jets layout D

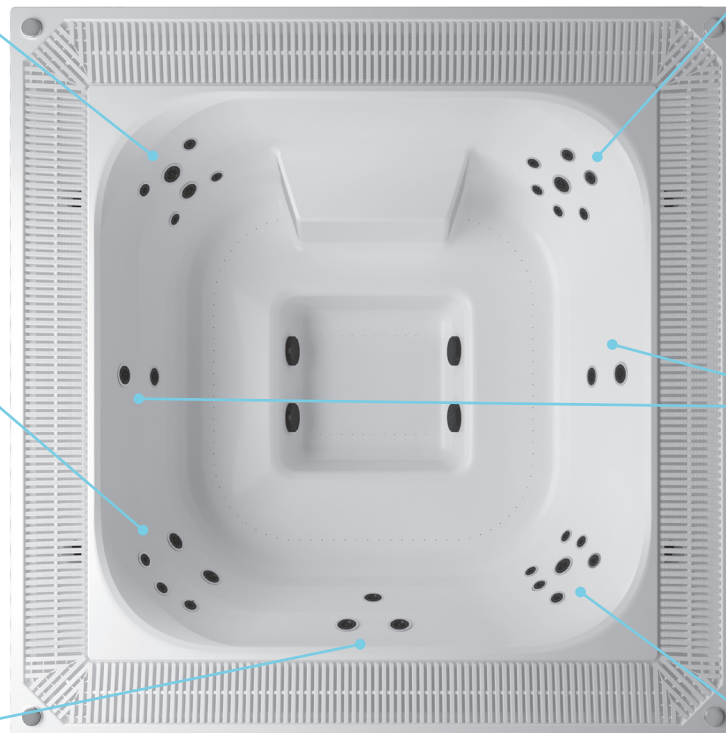

STATIONARY SPA BATHTUBS

MULTI-USER, PREPLUMBED VERSIONS

POOLSPA

JANETTE 175 × 193

with skimmer

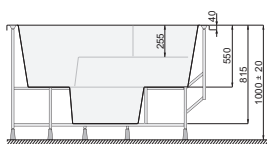
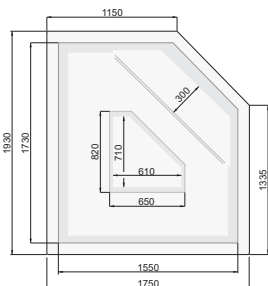

	PRODUCT / EQUIPMENT	CATALOGUE NO.	NET PRICE EUR
6 jets	SPA preplumbed with air channels	PWW8510U00B0000	7 200
	SPA preplumbed with air channels + white LED light	PWW8510U00B0209	7 600
	SPA preplumbed with air channels + 24 multicolor LED lights	PWW8510U00B1885	8 700
12 jets	SPA preplumbed with air channels	PWW8510U02B0000	8 400
	SPA preplumbed with air channels + white LED light	PWW8510U02B0209	8 800
	SPA preplumbed with air channels + 24 multicolor LED lights	PWW8510U02B1885	9 900
	Full foaming		570
	Brown thermal cover	PI9000315	1 800

GENERAL INFORMATION

length:	175 cm	number of jets:	6-12
width:	193 cm	number of air holes:	104
height:	100 ± 2 cm	number of suctions:	2-3
number of seats:	3	number of air regulators:	2-4
capacity:	700 l	number of massage points:	110-116

JANETTE 197 × 215

with gutter

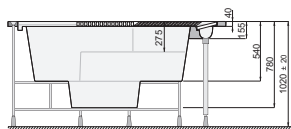
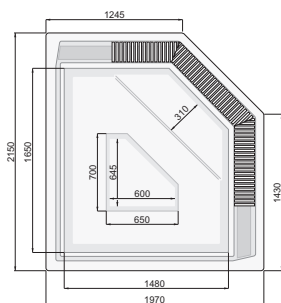

	PRODUCT / EQUIPMENT	CATALOGUE NO.	NET PRICE EUR
6 jets	SPA preplumbed with air channels	PWW8410U00B0000	9 400
	SPA preplumbed with air channels + white LED light	PWW8410U00B0209	9 800
	SPA preplumbed with air channels + 24 multicolor LED lights	PWW8410U00B1885	10 900
12 jets	SPA preplumbed with air channels	PWW8410U02B0000	10 600
	SPA preplumbed with air channels + white LED light	PWW8410U02B0209	11 000
	SPA preplumbed with air channels + 24 multicolor LED lights	PWW8410U02B1885	12 100
	Full foaming		570
	Brown thermal cover	PI9000316	2 200

GENERAL INFORMATION

length:	197 cm	number of jets:	6-12
width:	215 cm	number of air holes:	104
height:	102 ± 2 cm	number of suctions:	3-4
number of seats:	4	number of hidden air inlets:	2-4
capacity:	900 l	number of massage points:	110-116

	PRODUCT / EQUIPMENT	CATALOGUE NO.	NET PRICE EUR
32 jets	SPA preplumbed with air channels + white LED light	PWW8410U32B0209	12 900
	SPA preplumbed with air channels + 24 multicolor LED lights	PWW8410U32B1885	14 000
	Full foaming		570
	Brown thermal cover	PI9000316	2 200

JANETTE 197 × 215

with gutter, 32 jets

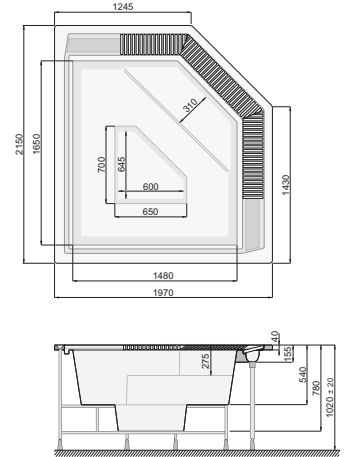

GENERAL INFORMATION

length:	197 cm	number of jets:	32
width:	215 cm	number of air holes:	104
height:	102 ± 2 cm	number of suctions:	4
number of seats:	4	number of hidden air inlets:	4
capacity:	900 l	number of massage points:	136

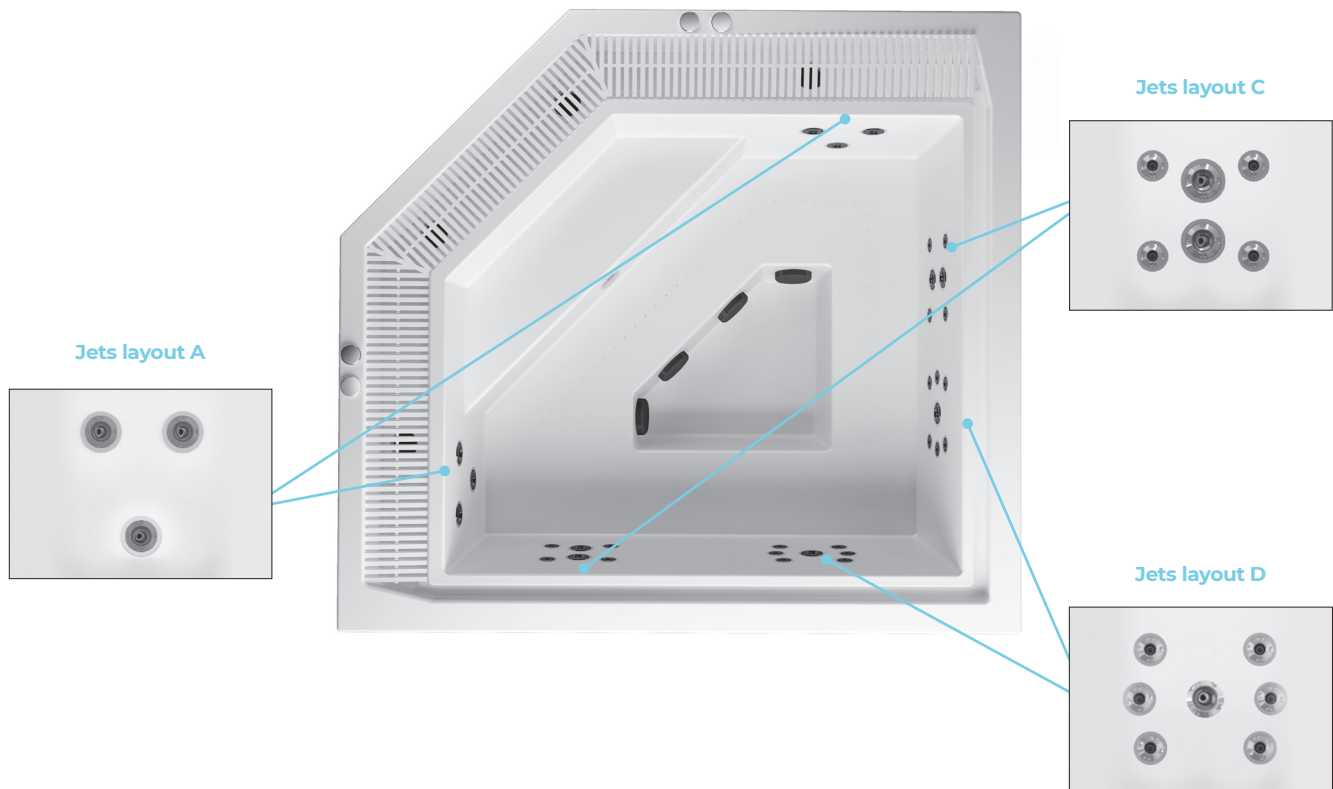

STATIONARY SPA BATHTUBS

MULTI-USER, PREPLUMBED VERSIONS

OCTAVIA 179 × 179

with skimmer

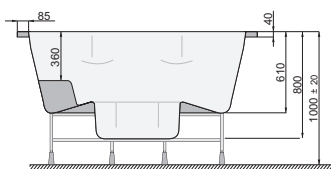
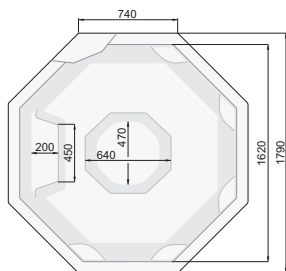

	PRODUCT / EQUIPMENT	CATALOGUE NO.	NET PRICE EUR
7 jets	SPA preplumbed with air channels	PWW8310U00B0000	7 300
	SPA preplumbed with air channels + white LED light	PWW8310U00B0209	7 700
	SPA preplumbed with air channels + 24 multicolor LED lights	PWW8310U00B1885	8 800
14 jets	SPA preplumbed with air channels	PWW8310U02B0000	8 700
	SPA preplumbed with air channels + white LED light	PWW8310U02B0209	9 100
	SPA preplumbed with air channels + 24 multicolor LED lights	PWW8310U02B1885	10 200
	Full foaming		570
	Brown thermal cover	PI9000317	1 800

GENERAL INFORMATION

length:	179 cm	number of jets:	7-14
width:	179 cm	number of air holes:	93
height:	100 ± 2 cm	number of suctions:	2-3
number of seats:	4	number of air regulators:	2-4
capacity:	850 l	number of massage points:	100-107

OCTAVIA 226 × 226

with gutter

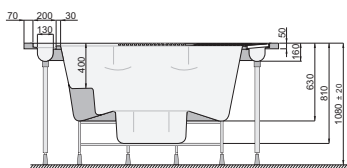
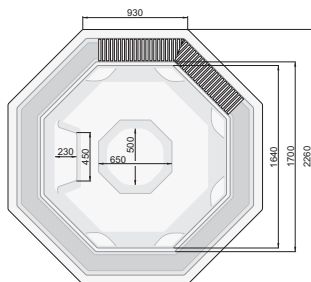

	PRODUCT / EQUIPMENT	CATALOGUE NO.	NET PRICE EUR
7 jets	SPA preplumbed with air channels	PWW8210U00B0000	9 900
	SPA preplumbed with air channels + white LED light	PWW8210U00B0209	10 300
	SPA preplumbed with air channels + 24 multicolor LED lights	PWW8210U00B1885	11 400
14 jets	SPA preplumbed with air channels	PWW8210U02B0000	11 300
	SPA preplumbed with air channels + white LED light	PWW8210U02B0209	11 700
	SPA preplumbed with air channels + 24 multicolor LED lights	PWW8210U02B1885	12 800
	Full foaming		570
	Brown thermal cover	PI9000318	2 200

GENERAL INFORMATION

length:	226 cm	number of jets:	7-14
width:	226 cm	number of air holes:	93
height:	108 ± 2 cm	number of suctions:	3-4
number of seats:	5	number of hidden air inlets:	2-4
capacity:	1050 l	number of massage points:	100-107

PRODUCT / EQUIPMENT	CATALOGUE NO.	NET PRICE EUR
32 jets SPA preplumbed with air channels + white LED light	PWW8210U32B0209	13 200
SPA preplumbed with air channels + 24 multicolor LED lights	PWW8210U32B1885	14 300
Full foaming		570
Brown thermal cover	PI9000318	2 200

OCTAVIA 226 × 226 with gutter, 32 jets

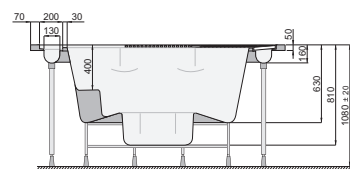
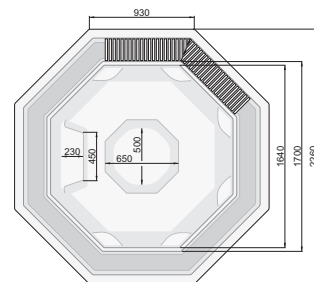

GENERAL INFORMATION

length:	226 cm	number of jets:	32
width:	226 cm	number of air holes:	93
height:	108 ± 2 cm	number of suctions:	4
number of seats:	5	number of hidden air inlets:	4
capacity:	1050 l	number of massage points:	125

Jets layout A

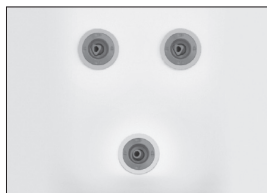

Jets layout B

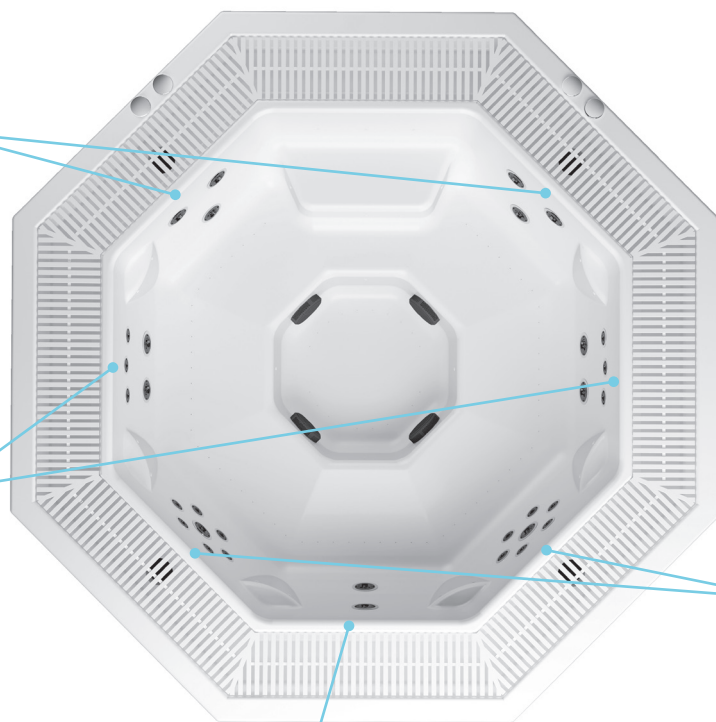
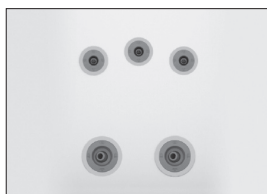

Jets layout E

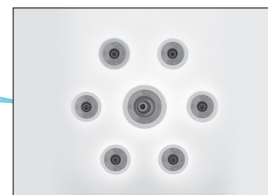

Jets layout F



STATIONARY SPA BATHTUBS

MULTI-USER, PREPLUMBED VERSIONS

POOLSPA

VICTORIA Ø 177

with skimmer

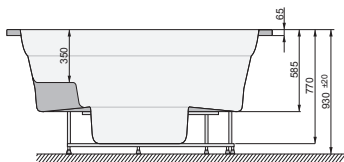
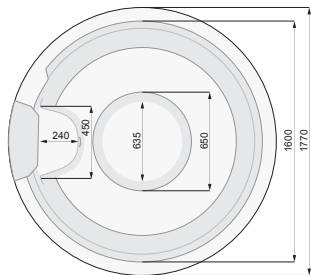

	PRODUCT / EQUIPMENT	CATALOGUE NO.	NET PRICE EUR
6 jets	SPA preplumbed with air channels	PWW8710U00B0000	7 000
	SPA preplumbed with air channels + white LED light	PWW8710U00B0209	7 400
	SPA preplumbed with air channels + 24 multicolor LED lights	PWW8710U00B1885	8 500
12 jets	SPA preplumbed with air channels	PWW8710U02B0000	8 200
	SPA preplumbed with air channels + white LED light	PWW8710U02B0209	8 600
	SPA preplumbed with air channels + 24 multicolor LED lights	PWW8710U02B1885	9 700
	Full foaming		570
	Brown thermal cover	PI9000264	1 800

GENERAL INFORMATION

length:	177 cm	number of jets:	6-12
width:	177 cm	number of air holes:	94
height:	93 ± 2 cm	number of suction:	2-3
number of seats:	4	number of air regulators:	2-4
capacity:	800 l	number of massage points:	100-106

VICTORIA Ø 249

with gutter

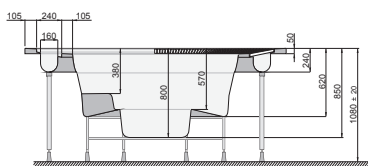
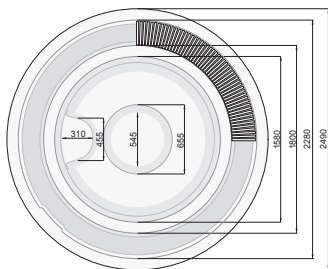

	PRODUCT / EQUIPMENT	CATALOGUE NO.	NET PRICE EUR
6 jets	SPA preplumbed with air channels	PWW8610U00B0000	9 600
	SPA preplumbed with air channels + white LED light	PWW8610U00B0209	10 000
	SPA preplumbed with air channels + 24 multicolor LED lights	PWW8610U00B1885	11 100
12 jets	SPA preplumbed with air channels	PWW8610U02B0000	10 800
	SPA preplumbed with air channels + white LED light	PWW8610U02B0209	11 200
	SPA preplumbed with air channels + 24 multicolor LED lights	PWW8610U02B1885	12 300
	Full foaming		570
	Brown thermal cover	PI9000308	2 500

GENERAL INFORMATION

length:	249 cm	number of jets:	6-12
width:	249 cm	number of air holes:	94
height:	108 ± 2 cm	number of suction:	3-4
number of seats:	5	number of hidden air inlets:	2-4
capacity:	1100 l	number of massage points:	100-106

	PRODUCT / EQUIPMENT	CATALOGUE NO.	NET PRICE EUR
32 jets	SPA preplumbed with air channels + white LED light	PWW8610U32B0209	12 900
	SPA preplumbed with air channels + 24 multicolor LED lights	PWW8610U32B1885	14 000
	Full foaming		570
	Brown thermal cover	PI9000308	2 500

VICTORIA Ø 249

with gutter, 32 jets

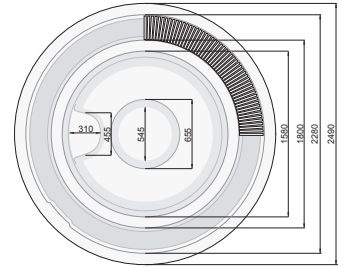

GENERAL INFORMATION

length:	249 cm	number of jets:	32
width:	249 cm	number of air holes:	94
height:	108 ± 2 cm	number of suctions:	4
number of seats:	5	number of hidden air inlets:	4
capacity:	1100 l	number of massage points:	126

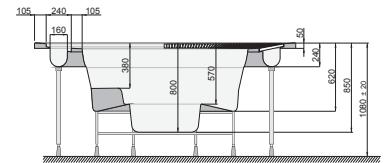

Jets layout A

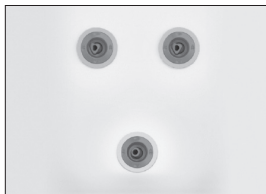

Jets layout C

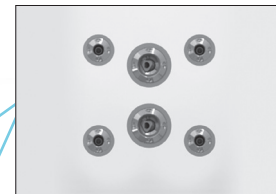

Jets layout E

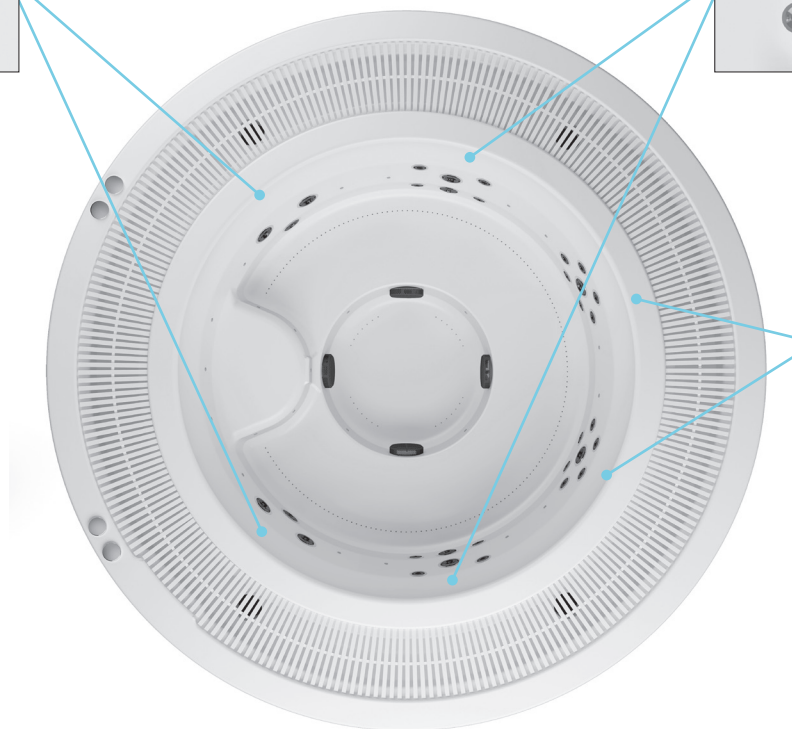
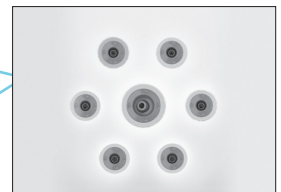

STATIONARY SPA BATHTUBS

MULTI-USER, PREPLUMBED VERSIONS

CLASSIC 186 × 213

with skimmer

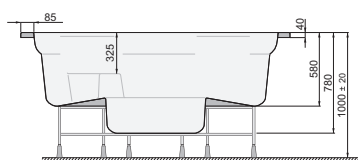
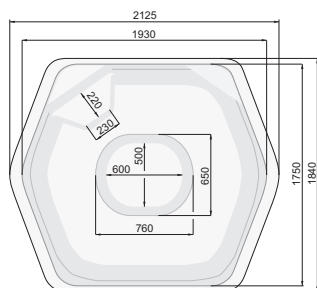

	PRODUCT / EQUIPMENT	CATALOGUE NO.	NET PRICE EUR
6 jets	SPA preplumbed with air channels	PWW8110U00B0000	6 900
	SPA preplumbed with air channels + white LED light	PWW8110U00B0209	7 300
	SPA preplumbed with air channels + 24 multicolor LED lights	PWW8110U00B1885	8 400
12 jets	SPA preplumbed with air channels	PWW8110U02B0000	8 100
	SPA preplumbed with air channels + white LED light	PWW8110U02B0209	8 500
	SPA preplumbed with air channels + 24 multicolor LED lights	PWW8110U02B1885	9 600
	Full foaming		570
	Brown thermal cover	PI9000319	2 000

GENERAL INFORMATION

length:	186 cm	number of jets:	6-12
width:	213 cm	number of air holes:	106
height:	100 ± 2 cm	number of suction:	2-3
number of seats:	4	number of air regulators:	2-4
capacity:	1100 l	number of massage points:	112-118

CLASSIC 260 × 234

with gutter

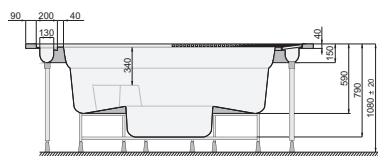
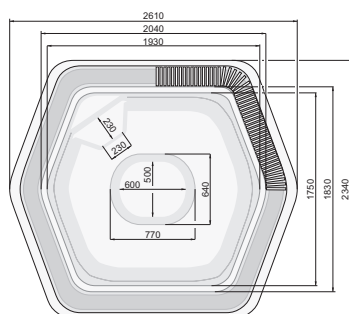

	PRODUCT / EQUIPMENT	CATALOGUE NO.	NET PRICE EUR
6 jets	SPA preplumbed with air channels	PWW8010U00B0000	9 300
	SPA preplumbed with air channels + white LED light	PWW8010U00B0209	9 700
	SPA preplumbed with air channels + 24 multicolor LED lights	PWW8010U00B1885	10 800
12 jets	SPA preplumbed with air channels	PWW8010U02B0000	10 500
	SPA preplumbed with air channels + white LED light	PWW8010U02B0209	10 900
	SPA preplumbed with air channels + 24 multicolor LED lights	PWW8010U02B1885	12 000
	Full foaming		570
	Brown thermal cover	PI9000320	2 300

GENERAL INFORMATION

length:	260 cm	number of jets:	6-12
width:	234 cm	number of air holes:	106
height:	108 ± 2 cm	number of suction:	3-4
number of seats:	5	number of hidden air inlets:	2-4
capacity:	1400 l	number of massage points:	112-118

PRODUCT / EQUIPMENT	CATALOGUE NO.	NET PRICE EUR
32 jets SPA preplumbed with air channels + white LED light	PWW8010U32B0209	12 900
SPA preplumbed with air channels + 24 multicolor LED lights	PWW8010U32B1885	14 000
Full foaming		570
Brown thermal cover	PI9000320	2 300

CLASSIC 260 × 234

with gutter, 32 jets

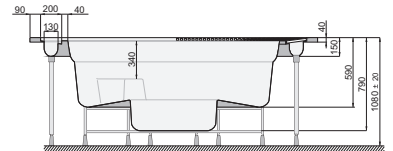
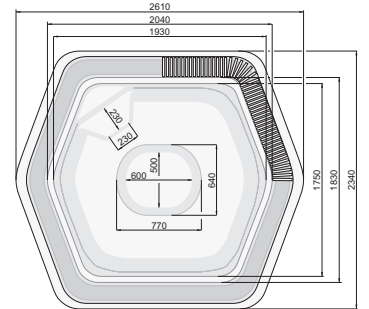

GENERAL INFORMATION

length:	260 cm	number of jets:	32
width:	234 cm	number of air holes:	106
height:	108 ± 2 cm	number of suctions:	4
number of seats:	5	number of hidden air inlets:	4
capacity:	1400 l	number of massage points:	138

Jets layout A

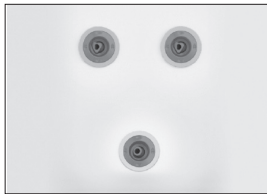

Jets layout C



Jets layout D

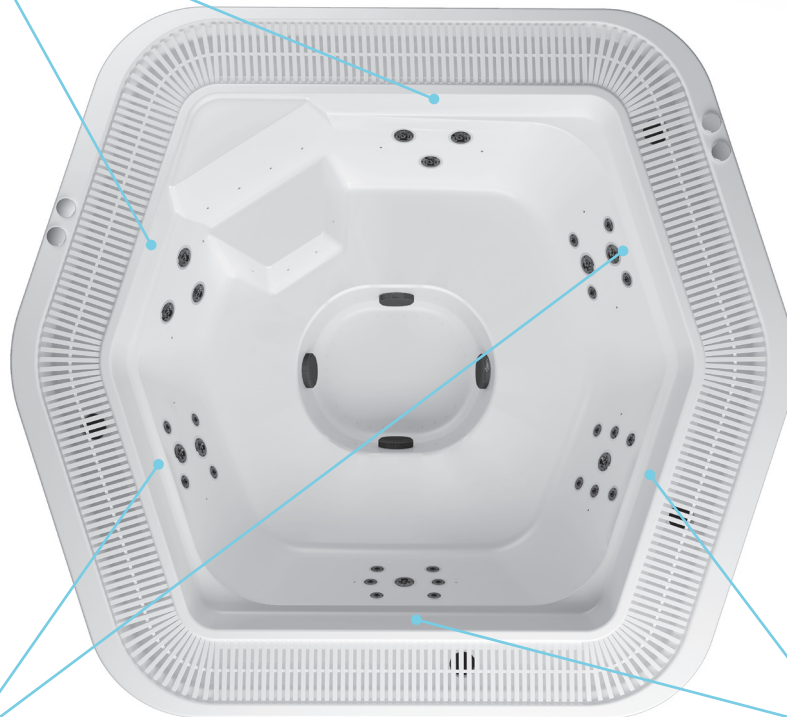

STATIONARY SPA BATHTUBS

MULTI-USER, PREPLUMBED VERSIONS

POOLSPA

NATALIE 253 × 253

with gutter

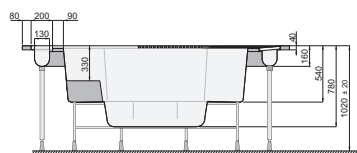
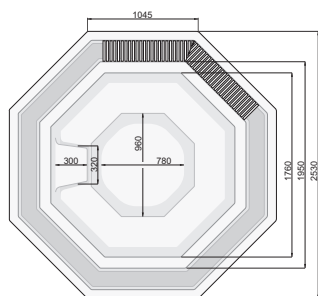

	PRODUCT / EQUIPMENT	CATALOGUE NO.	NET PRICE EUR
7 jets	SPA preplumbed with air channels	PWW8910U00B0000	10 200
	SPA preplumbed with air channels + white LED light	PWW8910U00B0209	10 600
	SPA preplumbed with air channels + 24 multicolor LED lights	PWW8910U00B1885	11 700
14 jets	SPA preplumbed with air channels	PWW8910U02B0000	11 600
	SPA preplumbed with air channels + white LED light	PWW8910U02B0209	12 000
	SPA preplumbed with air channels + 24 multicolor LED lights	PWW8910U02B1885	13 100
	Full foaming		570
	Brown thermal cover	PI9000321	2 500

GENERAL INFORMATION

length:	253 cm	number of jets:	7-14
width:	253 cm	number of air holes:	111
height:	102 ± 2 cm	number of suction:	3-4
number of seats:	5	number of hidden air inlets:	2-4
capacity:	1300 l	number of massage points:	118-125

PRODUCT / EQUIPMENT	CATALOGUE NO.	NET PRICE EUR
32 jets SPA preplumbed with air channels + white LED light	PWW8910U32B0209	14 000
SPA preplumbed with air channels + 24 multicolor LED lights	PWW8910U32B1885	15 100
Full foaming		570
Brown thermal cover	PI9000321	2 500

NATALIE 253 × 253

with gutter, 32 jets

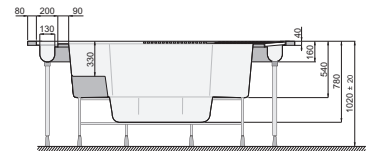
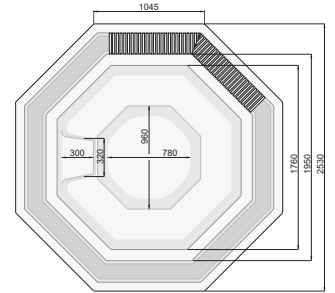

GENERAL INFORMATION			
length:	253 cm	number of jets:	32
width:	253 cm	number of air holes:	111
height:	102 ± 2 cm	number of suctions:	4
number of seats:	5	number of hidden air inlets:	4
capacity:	1300 l	number of massage points:	143

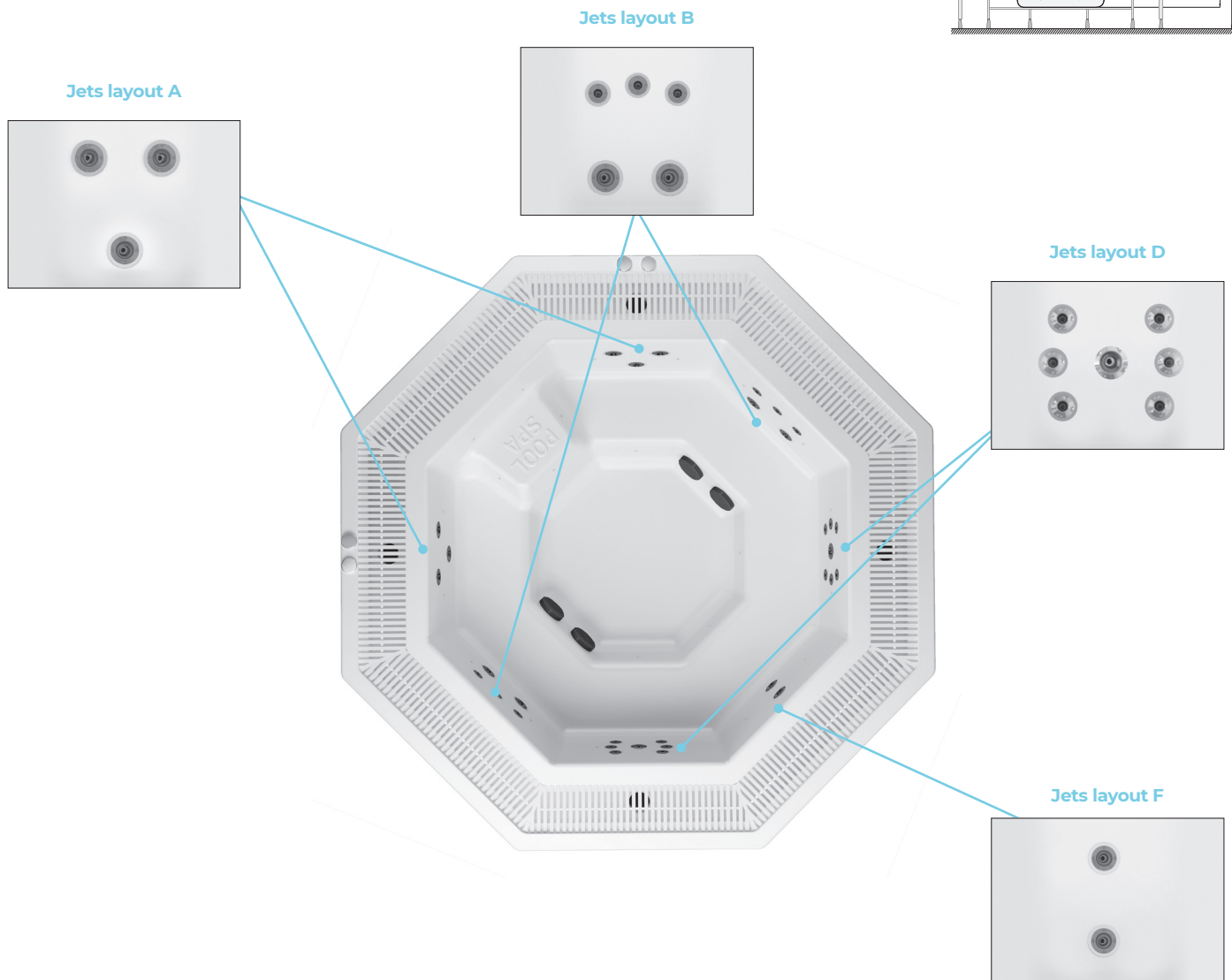

STATIONARY SPA BATHTUBS

MULTI-USER, PREPLUMBED VERSIONS

POOLSPA

SUNFLOWER Ø 283

with gutter

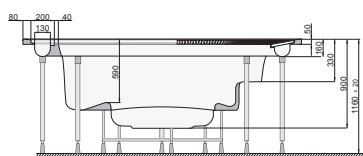
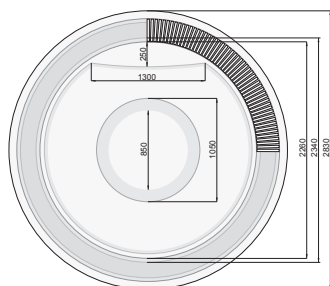

	PRODUCT / EQUIPMENT	CATALOGUE NO.	NET PRICE EUR
14 jets	SPA preplumbed with air channels	PWW8M10U00B0000	13 500
	SPA preplumbed with air channels + white LED light	PWW8M10U00B0209	13 900
	SPA preplumbed with air channels + 24 multicolor LED lights	PWW8M10U00B1885	15 000
	Full foaming		570
	Brown thermal cover	PI9000322	2 600

GENERAL INFORMATION

length:	283 cm	number of jets:	14
width:	283 cm	number of air holes:	142
height:	116 ± 2 cm	number of suction:	4
number of seats:	8	number of hidden air inlets:	4
capacity:	2000 l	number of massage points:	156

	PRODUCT / EQUIPMENT	CATALOGUE NO.	NET PRICE EUR
32 jets	SPA preplumbed with air channels + white LED light	PWW8M10U32B0209	15 200
	SPA preplumbed with air channels + 24 multicolor LED lights	PWW8M10U32B1885	16 300
	Full foaming		570
	Brown thermal cover	PI9000322	2 600

SUNFLOWER Ø 283

with gutter, 32 jets

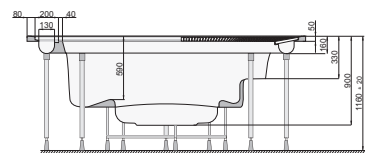
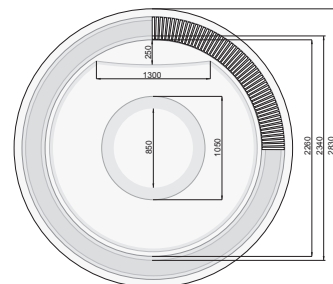

GENERAL INFORMATION

length:	283 cm	number of jets:	32
width:	283 cm	number of air holes:	142
height:	116 ± 2 cm	number of suctions:	4
number of seats:	8	number of hidden air inlets:	4
capacity:	2000 l	number of massage points:	174

Jets layout F



Jets layout A

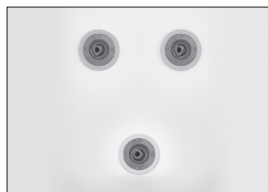

Jets layout B

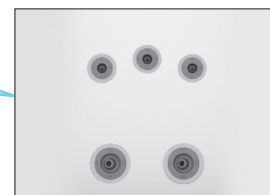

Jets layout C

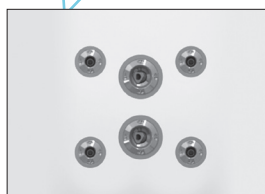

STATIONARY SPA BATHTUBS

MULTI-USER, PREPLUMBED VERSIONS

VESTA 230 × 230

with skimmer

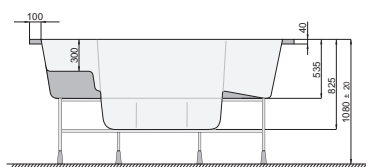
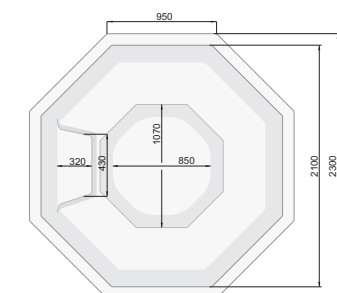

	PRODUCT / EQUIPMENT	CATALOGUE NO.	NET PRICE EUR
7 jets	SPA preplumbed with air channels	PWW8C10U00B0000	8 100
	SPA preplumbed with air channels + white LED light	PWW8C10U00B0209	8 500
	SPA preplumbed with air channels + 24 multicolor LED lights	PWW8C10U00B1885	9 600
14 jets	SPA preplumbed with air channels	PWW8C10U02B0000	9 500
	SPA preplumbed with air channels + white LED light	PWW8C10U02B0209	9 900
	SPA preplumbed with air channels + 24 multicolor LED lights	PWW8C10U02B1885	11 000
	Full foaming		570
	Brown thermal cover	PI9000324	2 100

GENERAL INFORMATION

length:	230 cm	number of jets:	7-14
width:	230 cm	number of air holes:	140
height:	108 ± 2 cm	number of suction:	2-3
number of seats:	7	number of air regulators:	2-4
capacity:	1100 l	number of massage points:	147-154

VESTA 290 × 290

with gutter

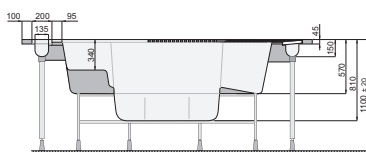
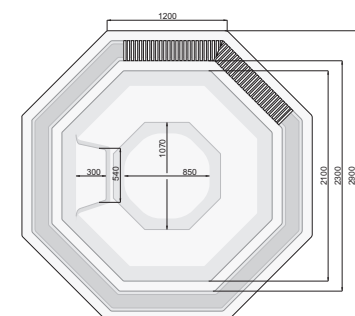

	PRODUCT / EQUIPMENT	CATALOGUE NO.	NET PRICE EUR
7 jets	SPA preplumbed with air channels	PWW8B10U00B0000	11 200
	SPA preplumbed with air channels + white LED light	PWW8B10U00B0209	11 600
	SPA preplumbed with air channels + 24 multicolor LED lights	PWW8B10U00B1885	12 700
14 jets	SPA preplumbed with air channels	PWW8B10U02B0000	12 600
	SPA preplumbed with air channels + white LED light	PWW8B10U02B0209	13 000
	SPA preplumbed with air channels + 24 multicolor LED lights	PWW8B10U02B1885	14 100
	Full foaming		570
	Brown thermal cover	PI9000323	2 600

GENERAL INFORMATION

length:	290 cm	number of jets:	7-14
width:	290 cm	number of air holes:	140
height:	110 ± 2 cm	number of suction:	3-4
number of seats:	7	number of hidden air inlets:	2-4
capacity:	1600 l	number of massage points:	147-154

STATIONARY SPA BATHTUBS

MULTI-USER, PREPLUMBED VERSIONS

OLIVIA 248 × 299

with gutter

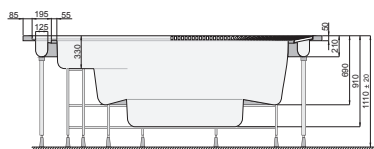
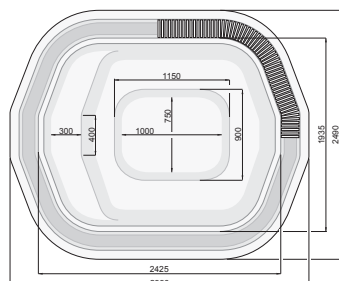

	PRODUCT / EQUIPMENT	CATALOGUE NO.	NET PRICE EUR
13 jets	SPA preplumbed with air channels	PWW8810U00B0000	12 200
	SPA preplumbed with air channels + white LED light	PWW8810U00B0209	12 600
	SPA preplumbed with air channels + 24 multicolor LED lights	PWW8810U00B1885	13 700
	Full foaming		570
	Brown thermal cover	PI9000325	2 600

GENERAL INFORMATION

length:	248 cm	number of jets:	13
width:	299 cm	number of air holes:	161
height:	111 ± 2 cm	number of suctions:	4
number of seats:	7	number of hidden air inlets:	4
capacity:	2100 l	number of massage points:	174

	PRODUCT / EQUIPMENT	CATALOGUE NO.	NET PRICE EUR
32 jets	SPA preplumbed with air channels + white LED light	PWW8810U32B0209	14 200
	SPA preplumbed with air channels + 24 multicolor LED lights	PWW8810U32B1885	15 300
	Full foaming		570
	Brown thermal cover	PI9000325	2 600

OLIVIA 248 × 299

with gutter, 32 jets

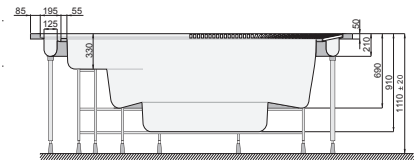
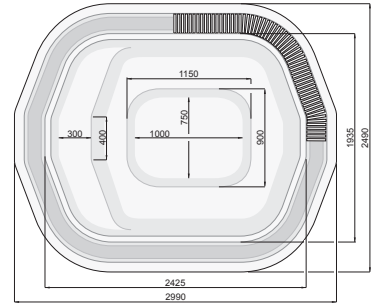

GENERAL INFORMATION

length:	248 cm	number of jets:	32
width:	299 cm	number of air holes:	161
height:	111 ± 2 cm	number of suctions:	4
number of seats:	7	number of hidden air inlets:	4
capacity:	2100 l	number of massage points:	193

Jets layout A

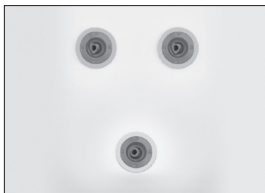

Jets layout B



Jets layout F



Jets layout D

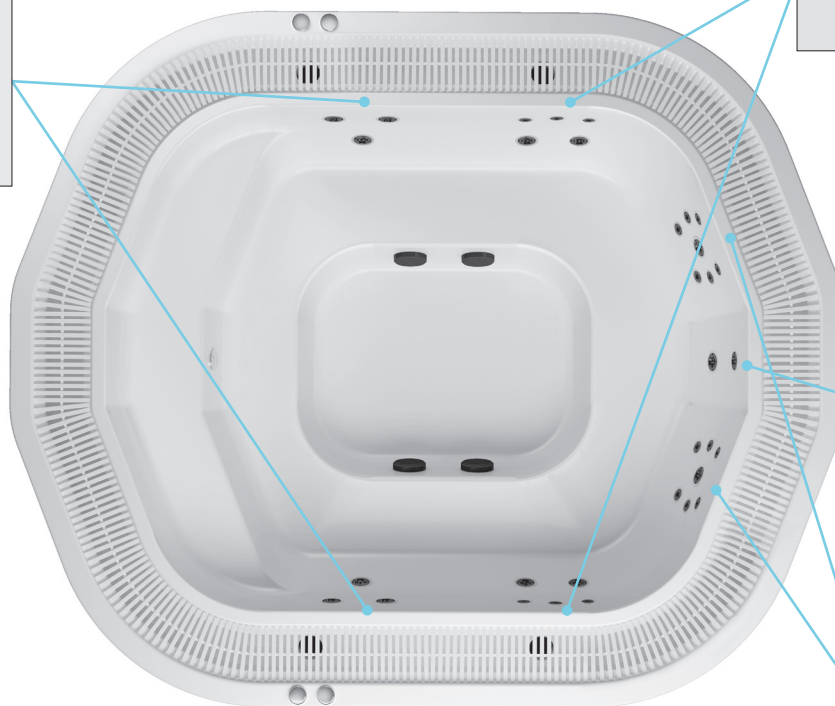
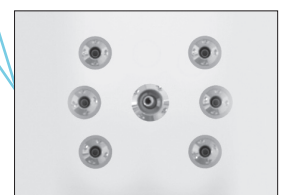

from pump supply for hydromassage Ø63

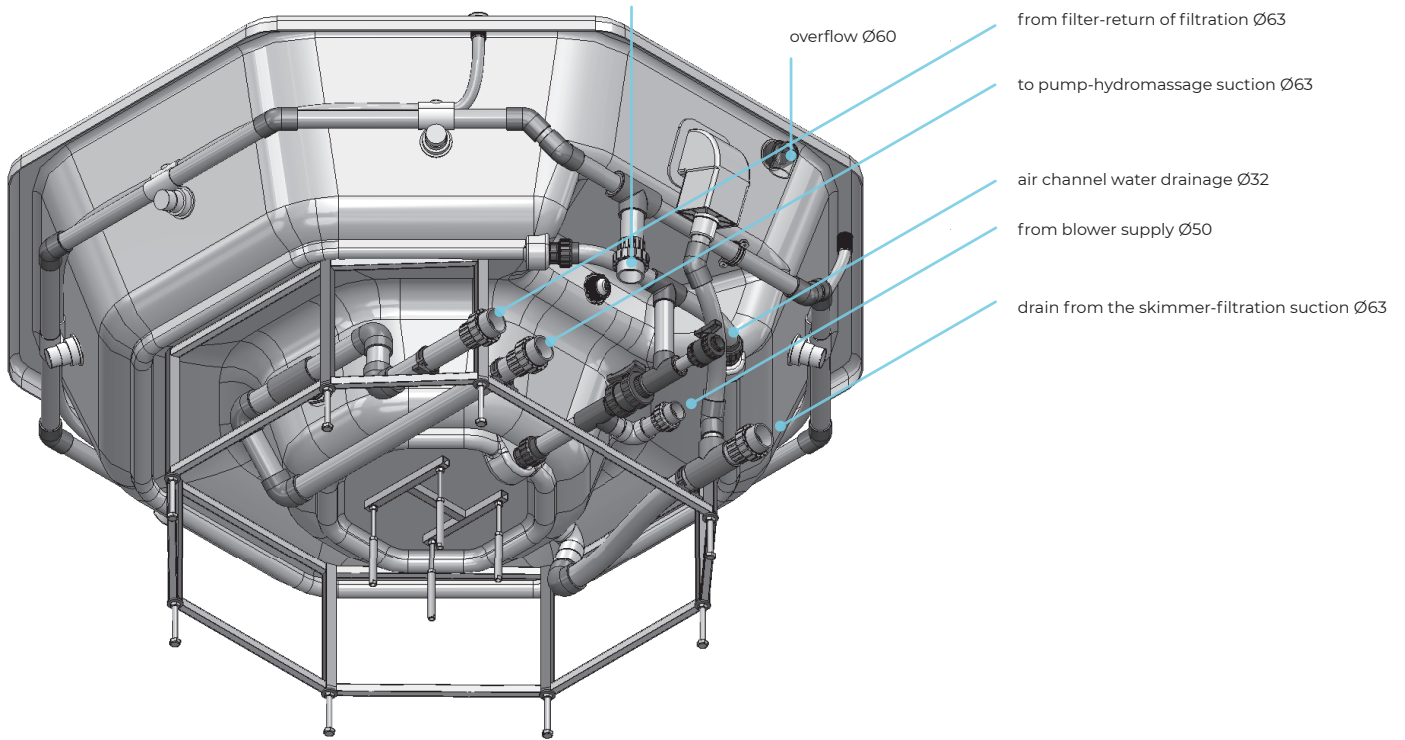

Plumbing scheme for a SPA bathtub with a skimmer and a single number of jets, as found in the Vesta bathtub.

overflow Ø60

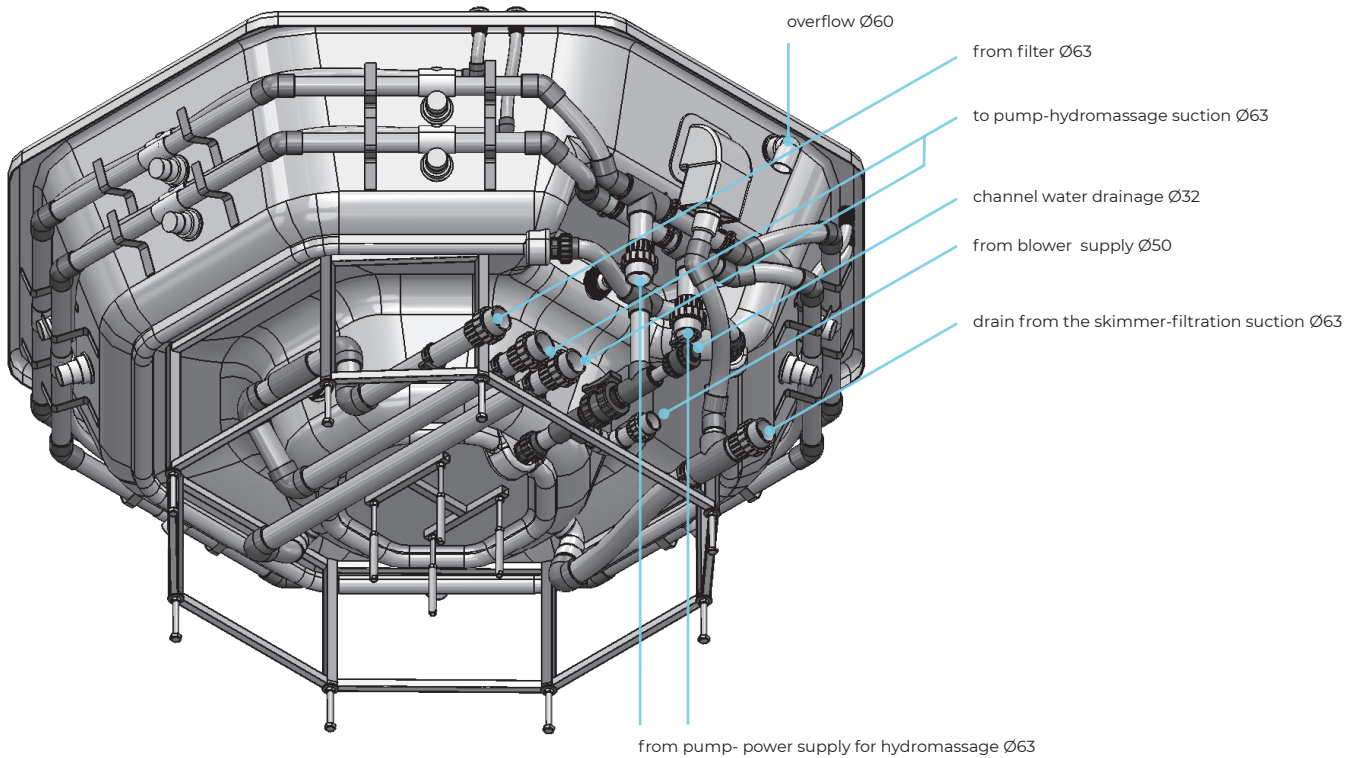

Plumbing scheme for a SPA bathtub with a skimmer and a double number of jets, as found in the Vesta bathtub.

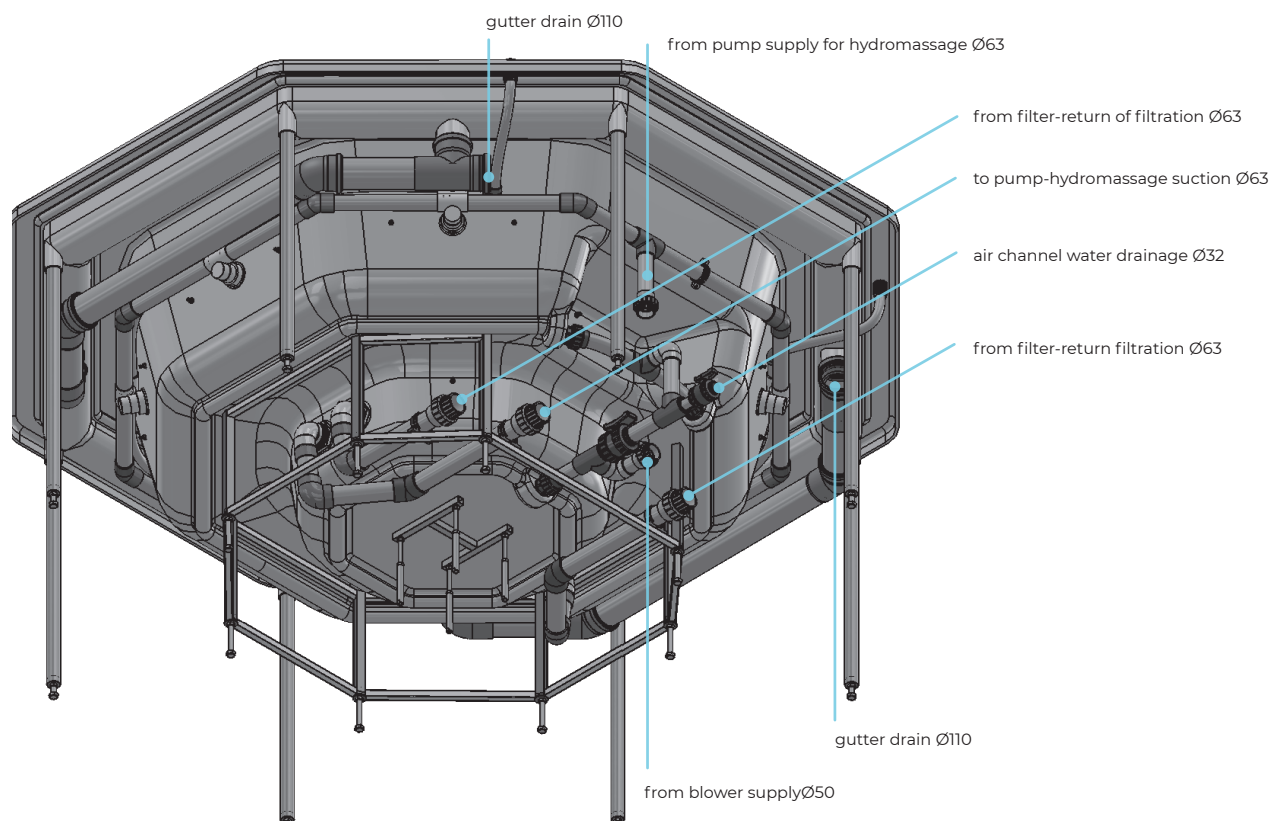

Plumbing scheme for a SPA bathtub with a gutter and a single number of jets, as found in the Vesta bathtub.

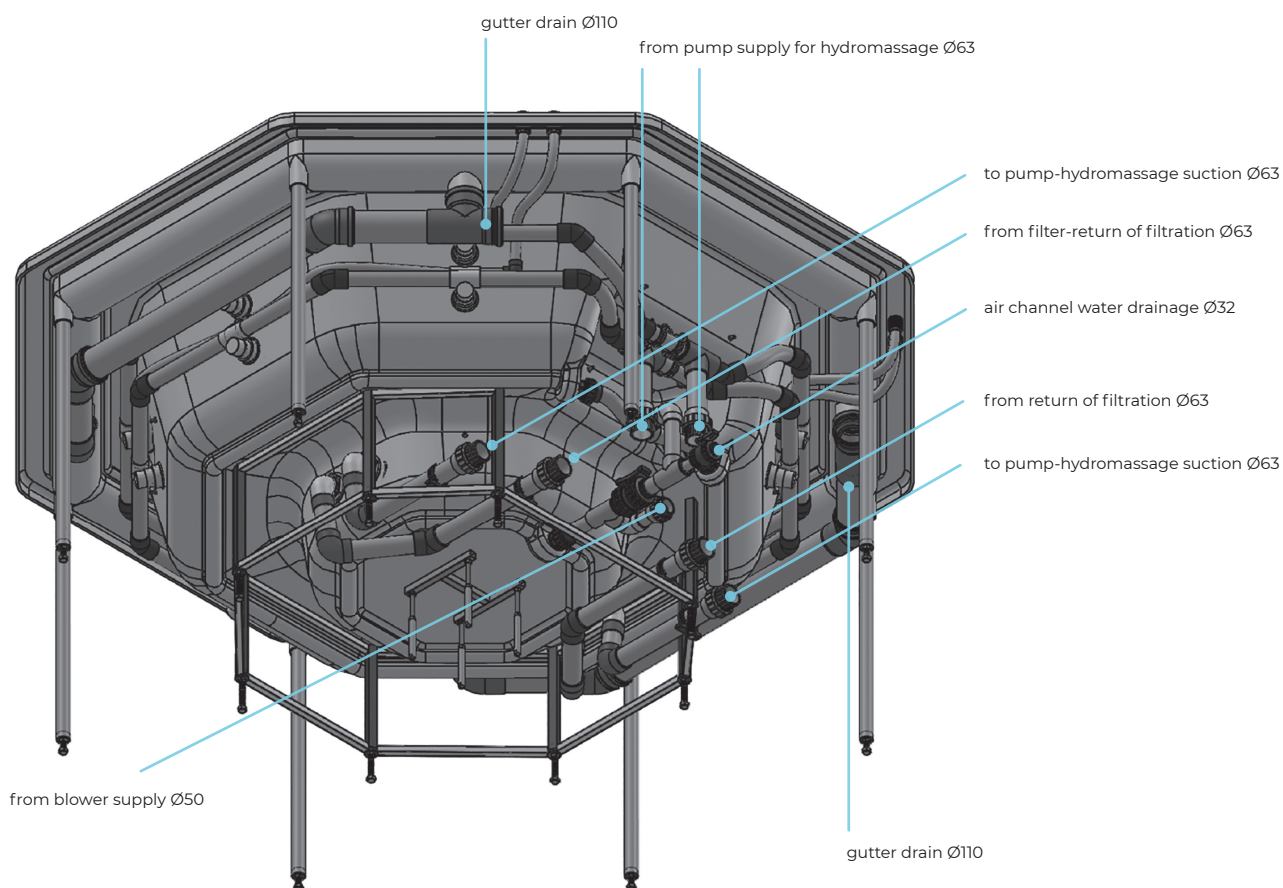

Plumbing scheme for a SPA bathtub with a gutter and a double number of jets, as found in the Vesta bathtub.

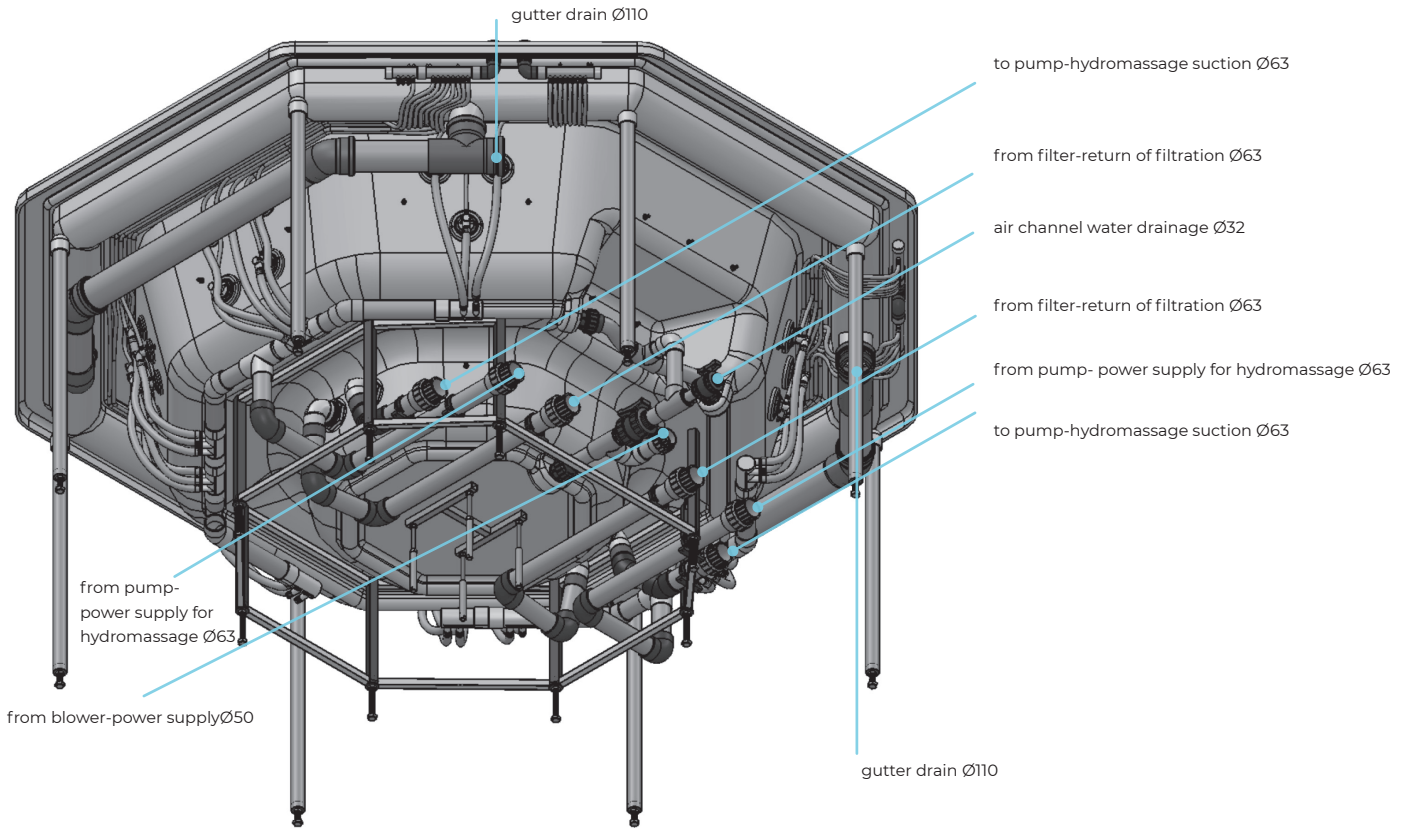

Plumbing scheme for a SPA bathtub with a gutter and 32 jets, as found in the Vesta bathtub.

Jets in standard SPA bathtubs:



Jet SPA Magna - stainless steel

Jets in SPA bathtubs with 32 Jets:



Rotating Jet A 2.5 slim



Fixed Jet A 3.5 slim



Rotating Jet A 3.5 slim

1. The warranty provisions below apply to all products manufactured by Roca Pool-Spa Sp. z o.o., further referred to in these Warranty Terms and Conditions as the "Seller".
2. The Seller warrants that the products were constructed and manufactured without defects and will operate faultlessly if used as the manufacturer's instructions.
3. The warranty shall cover all manufacturing defects or failures during the warranty period that are attributable to the manufacturer, and shall result in free repair or replacement of parts, and if it is not possible – replacement of the entire device.
4. The Seller shall provide warranty to the Buyer for the following categories of products:

PRODUCT CATEGORY	PRODUCT SURFACE	OTHER ELEMENTS
SPA products	5 years	2 years
composite products	5 years	2 years
solid surface products	5 years	2 years
acrylic products	5 years	2 years
hydro massage products	5 years	2 years
faucets	---	2 years

5. The warranty period shall start on the date of product purchase indicated on the proof of purchase.
6. The external surface of the product should be inspected by the Buyer at the place of purchase (also if the product is in the original packaging). Any later complaints about external damage filed following product collection or assembly shall not be allowed.
7. Before you start assembling the product, you must inspect it for completeness and any visible damage. The Seller shall not be liable for damages caused as a result of installation of the product with a visible defect.
8. Any product defects and damages that you notice must be reported to the Point of Purchase within 7 days from their occurrence, otherwise the warranty shall be void. If it is not possible to contact the Point of Purchase, you must notify the Seller's Service Department in writing, within the deadline indicated above.
9. Any damages to the product identified during the warranty period and not attributable to the Buyer shall be removed for free within 21 calendar days from the receipt of the damage report from the Buyer unless removal of the defect requires spare parts that may have a delivery time longer than 21 days for reasons not attributable to the Seller.
10. The Seller shall reserve its right to decide during defect removal whether parts of the product should be repaired or replaced with new parts. Defective (replaced) parts shall become the property of the Seller.
11. The product should be installed in a manner that enables convenient service access. Convenient service access must enable removal (for repair or replacement) of the product without generating additional costs (of material or labour) related to the product or other interior or building components into which the product was permanently embedded. The Seller shall not cover the costs (of materials or labour) associated to the removal of the claimed product.
12. Costs of unjustified complaint, in particular the costs of transport and labour shall be calculated on the basis of the Seller's price list applicable for maintenance service, inspections, examinations and expert opinions and shall be covered by the Buyer.
13. Warranty repairs shall not include activities performed normally during product use such as regular maintenance, decalcification, cleaning, which must be performed by the user at their own expense.
14. After the expiry of the warranty period, the Seller shall provide payable post-warranty service.
15. This warranty shall not exclude, limit or withhold the Buyer's rights arising from non-conformity of the product with the agreement.
16. For hydro massage tubs, for the warranty to be valid, the tubs must be installed by an installer with electric qualification certificate.
17. The warranty shall not apply to products sold at a discount.
18. The Buyer's warranty shall be voided if:
 - non-original parts are used,
 - the product is not used as intended
 - additional devices are mounted on the product
 - in the case of damage caused when making holes for faucets
 - in the case of mechanical damage, e.g. strike, chipping, scratching (including fittings)
 - damage caused by water impurity, scale deposits or lack of filters for mechanical impurities
 - non-compliance with the rules for operation, handling and maintenance included in product manuals
 - repairs or conversions performed by persons who were not authorised to do so by the Seller.
19. The Seller shall not be liable for any damages to individuals or assets that may be caused by any of the reasons referred to in item 18.

For warranty claims, please contact:

Roca Pool-Spa Sp. z o.o.
 ul. Dąbskiego 35, 72-300 Gryfice
 phone: +48 91 38 777 00
 www.poolspace.pl, e-mail: poolspace@pl.roca.com

The Manufacturer reserves the right to modify the appearance, design or parameters of the products shown in this product catalogue without advance notice. The interior design of areas shown in this catalogue may not necessarily meet requirements for a properly designed plumbing system. Actual product colours may vary from colours shown in the catalogue. This brochure does not constitute an offer within the meaning of applicable regulations.

This price list does not constitute an offer within the meaning of applicable regulations. The manufacturer reserves the right to make adjustments to both products and prices. Furthermore, the Manufacturer assumes no liability for printing errors. Prices in individual stores may vary from the above recommended prices, depending on the type and level of pre- and after-sales service provided by the Seller.

The brand you can trust!

DEVELOPMENT FOR CUSTOMERS BENEFIT

As the forerunner of the wellness idea, POOLSPA is the market leader among the manufacturers of luxury hydro-massage devices. It owes this top position to many years of experience as well as constant search for innovative solutions that would provide its Customers with better health, beauty and physical and mental state.

POLISH MANUFACTURER - GLOBAL POWER

POOLSPA products are made in Poland where the company located one of the most modern plants in this business. Therefore the customers can be serviced promptly and they can rely on the delivery of the ordered goods and their parts on time as well as on reasonable prices and the European quality level.

INNOVATIVE TECHNOLOGIES

Offered under the POOLSPA brand, modern products, made in composite and conglomerate technology open up new possibilities for the interior design of bathrooms and bathing rooms. The combination of all the features of modern design and unique material created for bathroom spaces is ideal for everyday use.

TOP QUALITY ACRYLIC

POOLSPA products are the choice for years. The application of top quality sanitary acrylic makes the products long lasting and all models perfect finishing together with the thorough material quality control during the technological process help to ensure a long guarantee time for each item. Touching any POOLSPA bath feels smooth, warm and pleasant and its colour is intense and durable.

COMPONENTS FROM REPUTED SUPPLIERS

All the devices bearing POOLSPA logo combine a sophisticated design with the highest functional values. They are all made with a special care even about the tiniest detail with regard to both, their aesthetic look and their reliability. There is no place left for any quality compromise - the company's suppliers are the leading world-wide bath components manufacturers.

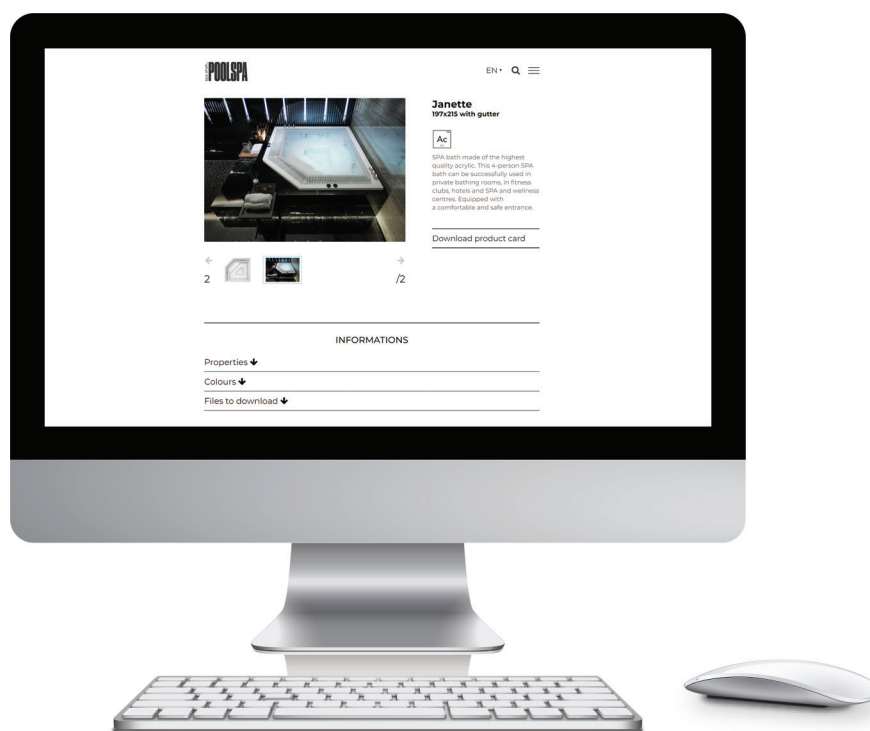

POOLSPA

Roca Pool-Spa Sp. z o.o.
ul. Wyczółkowskiego 20
44-109 Gliwice

www.poolspa.pl

Production Plant
ul. Jana Dąbskiego 35
72-300 Gryfice

phone: +48 91 38 777 00
fax: +48 91 38 777 01
poolspa@pl.roca.com

